

Electrostatic Sprayer User Manual

Warning: If the solution overflows from the mouth of the barrel, and wet the outer surface of the barrel and the clothes and body of the operator, it will easily lose the electrostatic adsorption effect and cause poisoning and static leakage to stimulate the operator's skin. Therefore, be sure to tighten the lid during operation.

During operation, be sure to tighten the lid to prevent the liquid from overflowing from the mouth of the bucket. If the soluble powder is sprayed, the pump and nozzle should be immediately after spraying is completed and the sprayer charged after the operation.

Keeping the spray bar tightly connected and the surface of the barrel dry and clean is very important to ensure the safe operation of the sprayer.

The electrostatic adsorption effect and comfortable control wants a dry backpack container.

When using the air gun for spraying, be sure to turn on the air gun motor before starting the water pump for spraying; when turning off the air gun, you should first cut off the power of the water pump and then cut off the power of the air gun, so as to prevent moisture caused by the inside of the air gun

Never use liquids that are corrosive to plastics and metals to avoid damaging important parts such as the storage tank, water pump, and nozzle. This machine cannot use wettable powder.

Electrostatic sprayer refers to a sprayer that can cause the sprayed droplets to produce a significant electrostatic entrapment adsorption effect on the target. This sprayer is a multifunctional 12v powered electric electrostatic sprayer and the sprayer generates the static electricity charge in the base of the backpack.

The sprayer offers several operating modes such as electric spray, low-volume spray, air-blast spray and electrostatic spray. The sprayer offers significant cost reduction and is an ideal high-efficiency plant protection and pesticide sprayer in the field of plant diseases and insect pests prevention and control.

The sprayers multiple spray modes supports the various areas in and around structures and buildings that need sanitation and epidemic prevention and disinfection and insecticide in modern living areas.

Description of safety warning signs



Protective coverall, Protective masks, Gloves, Cleaning

Content

- 1) Safety and Operation Precautions
- 2) Working Principle
- 3) Scope of Application
- 4) Technical Parameters
- 5) How to Use
- 6) Product Structure
- 7) Packing list

1) Safety and Operation Precautions

1. Please be sure to properly filter the chemical liquids and water to ensure there is no solid particles, this is to avoid clogging the nozzle and negatively impacting the spraying operation.
2. If the nozzle is blocked, stop the machine, remove the particulate matter and the machine can be turned on again.
3. The operator must wear personal protective equipment based upon the chemicals used to avoid harming the operator caused by direct body contact with the chemicals.
4. Do not spray chemicals that have a corrosive effect on plastics and metals. Do not Spray Flammable products.
5. After the machine is used, the interior of the tank and the spraying system should be cleaned with clear water and wiped clean, and placed in a clean dry area for storage.
6. Cleaning method: After spraying the liquid medicine, pour clean water into the storage tank, and spray it for 15 seconds after starting up, pour out the remaining clean water and wipe it clean.
7. Do not immerse the Air Gun or Backpack in water to prevent the motor, battery and electronic components from being damaged by moisture.
8. Do Not use the use the electrostatic sprayer in a flammable and explosive environment.
9. During operation, pay attention to keep the outer surface and handle of the barrel in a clean and dry state.
10. Do not make contact with other people during the operation
11. Do Not touch the boom and the charging socket of the barrel during operation.
12. Please note that if an alarm sounds in the machine (lead-acid battery), the battery needs to be charged. After charging, please let the system rest for 10 minutes before use.
13. For optimal performance the battery should be maintained and charged no less than once a month. Correct use and maintenance of the battery can greatly extend the service life of the battery.
14. There are tens of thousands of volts of static electricity generated by this sprayer, do not disassemble the machine yourself.
15. Do not spray chemicals such as strong acids and bases.
16. When using pesticides, follow the safety instructions provided by pesticide manufacturers.
17. Due to the high humidity and water vapor in the greenhouse, please do not store the machine in the greenhouse to avoid dampening the electrical circuits in the machine, affecting the electrostatic adsorption effect of the spray and generating electrostatic leakage.

2) Working Principle

This machine uses a 12V lead-acid battery or a can support an optional lithium battery as a power source. The high-voltage electrostatic generator charges the liquid electrolyte with one polarity of static charge. At the same time, the target is charged with the opposite polarity of static charge by means of a static charge generator in the base.

After being pressurized by the diaphragm pump, the disinfectant/pesticide liquid with a polar static charge is directly sprayed out from the small nozzle hole, or when using the air gun a fine mist of droplets are sent a long distance via the fan in the the air gun.

The sprayed fine droplets with a positive polar static charge and under the combined action of spraying force and the electrostatic force, directly run to the negative sides of the target with the opposite polar static charge. The Target a hard surface or a leaf of the plant will firmly attach to the solution sprayed, and will achieve and efficient disinfection, insecticide and/or sanitization.

3) Scope of Application

This machine is suitable for the control of diseases and insect pests of low and sparse crops and various agricultural and forest crops such as tea, tobacco, flowers, fruit trees and other crops (especially suitable for greenhouse crops).

It can be used for spraying disinfectants, sanitizing agents, insecticides, fungicides, herbicides, plant hormones, fertilizers, etc., and is designed for sanitation and epidemic prevention and disinfection of environments such as factories, warehouses, stations, docks, hotels, trains, buses, cars, airports, farms, and livestock and pest extermination.

The Sprayer can easily spray all kinds of water, liquides, soluble powders and emulsions.

After spraying soluble powder, the pump and nozzle should be cleaned in time.

4) Technical Parameters

Dimensions mm	380×190×540	Working speed	3000-15000m ² /hour
Net weight kg (With battery)	5.6 (Lead-acid batteries)	Spray range	~2.5m (Boom swing)
	4.1 (Lithium battery)		~6m (Air gun swing)
Liquid capacity L	16	Working time after a full charge	(Boom) ~6 hours (Blow gun) ~1.5hours
Operating voltage V	12	Fog droplet median diameter	40-90 um
Working pressure MPa	0.15-0.4	Spray flow	Hourly 4-12 liters
Battery capacity	12V 8-18aH	Static generator output voltage	15-30KV
Charger input / Output voltage V	AC110- 240 / DC12-14.8	Air gun net weight	1.5KG

Air Gun Connection and Operating Instruction

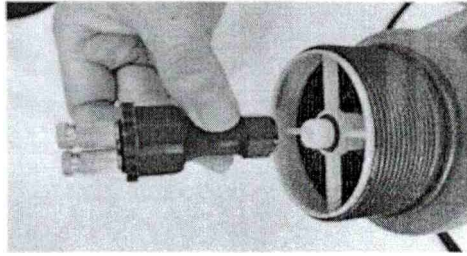

1. When installing the fine mist 3 nozzle, please properly tighten.

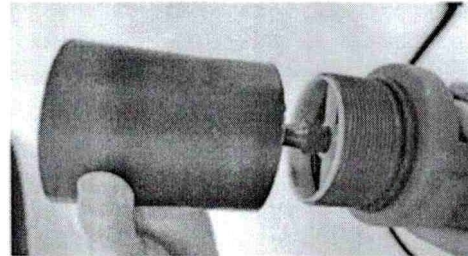

2. Install the nozzle protective cover.

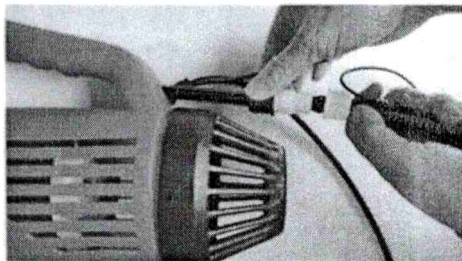

3. Connect and tighten the Inlet pipe to the air gun and the outlet pipe of the sprayer

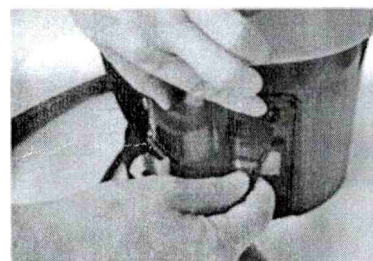

4. Connect the power plug of the air gun to the power socket of the sprayer.

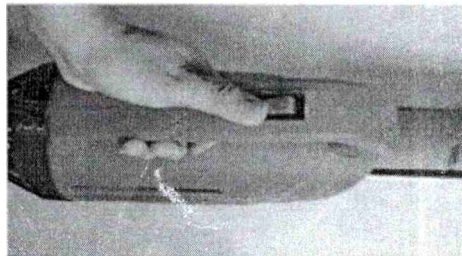

5. Turn on the power switch of the air gun first.

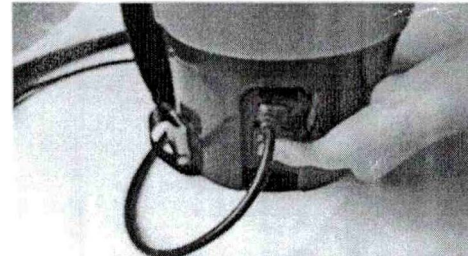

6. Turn on the power switch of the sprayer next .

Note:

1. When using always turn on the power for the air gun **first** before turning on the power for the sprayer.
2. When turning off, always power off the sprayer first before powering off the air gun. Pay attention to the order of operations to avoid impacting sprayer performance.
3. When spraying, you should follow the wind and avoid spraying against the wind to avoid affecting the impacting the operator with the chemical being sprayed.

Trigger Sprayer and Wand Switch Connection and Operating Instruction

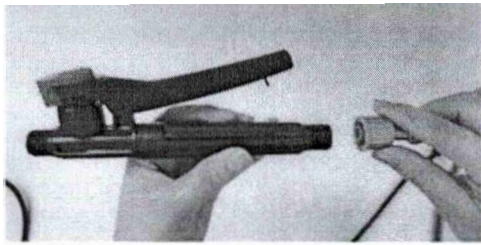

1. Connect and tighten one end of the handle switch to the outlet pipe of the sprayer.

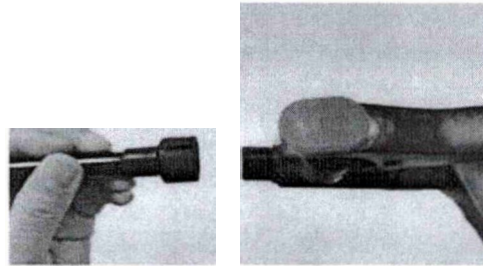

2. Connect and tighten the boom to the handle switch.

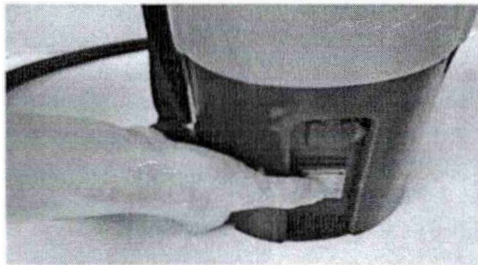

3. Turn on the power switch of the sprayer.

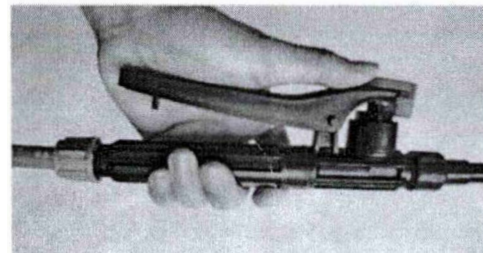

4. When spraying, hold the handle and press the flow switch.

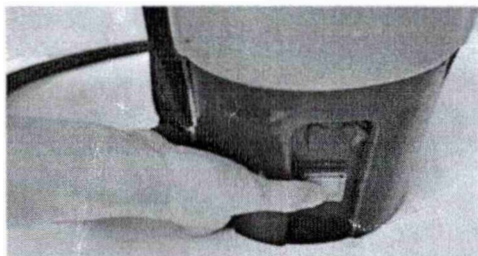

5. The power switch should be turned off after spraying

5) How to Use

1. Reference method for dispensing: Refer to the instructions of the pesticide packaging, subtract about 60% of the indicated amount of chemical, after fully dissolving in appropriate amount of water and filtering, pour inside the bucket, wipe off the water on the outside of the bucket, and close the lid tightly.
2. Note the liquid added to the barrel must be fully filtered, otherwise it will cause clogging of the nozzle and affect the normal spray operation and prevention and control effect. The specific dosage of chemical/pesticide and water can also be adjusted according to the speed of each person spraying to accommodate the building area as well as the height and density of crops. When handling pesticides, follow the safety instructions provided by the pesticide manufacturer.
3. Operation sequence: Tighten the lid of the bucket after dispensing, carry the storage bucket on operator's back, hold the handle of the spray rod, and then turn on the main switch of the base of the bucket to spray the nozzle towards the crop.
4. When the air gun is sprayed, the air gun switch should be turned on first, and then the barrel base switch. After spraying, the base switch of the barrel should be turned off first, and then the air gun switch should be turned off.
5. Spraying method: when spraying, start from the upper wind head of the field or outside area to be sanitized, position the spray wand so the spray head is in front operator and chemical/pesticide is sprayed while walking forward along the wind direction. When spraying with the fine mist Air Gun proceed to spray so that the wind carries the mist and it falls on the target surface or crops to avoid contamination to the operator.
6. When spraying, you can walk at a speed of more than one step per second. When spraying with the boom, the spray width (including swinging) is about 2.5 meters (8 feet).
7. Grounding device: In order to strengthen the electrostatic absorption effect of the spray, the machine is equipped with an ionized air grounding electrode on the body. During operation, the charge is conducted by air ionization to enhance the electrostatic absorption effect.
8. Spraying time: During the hot summer season, the effect of spraying before 11 am and after 2 pm is better (the greenhouse operation is not limited to this). However, in windy weather, the direction and range of the fog may be difficult to control due to the influence of the wind. Therefore, it is not suitable for use. It is not suitable for use in rain and snow and thick fog. The ambient temperature of this machine is above 0°C to below 40°C. (32 degrees F to 104 degrees F)

6) Product Structure

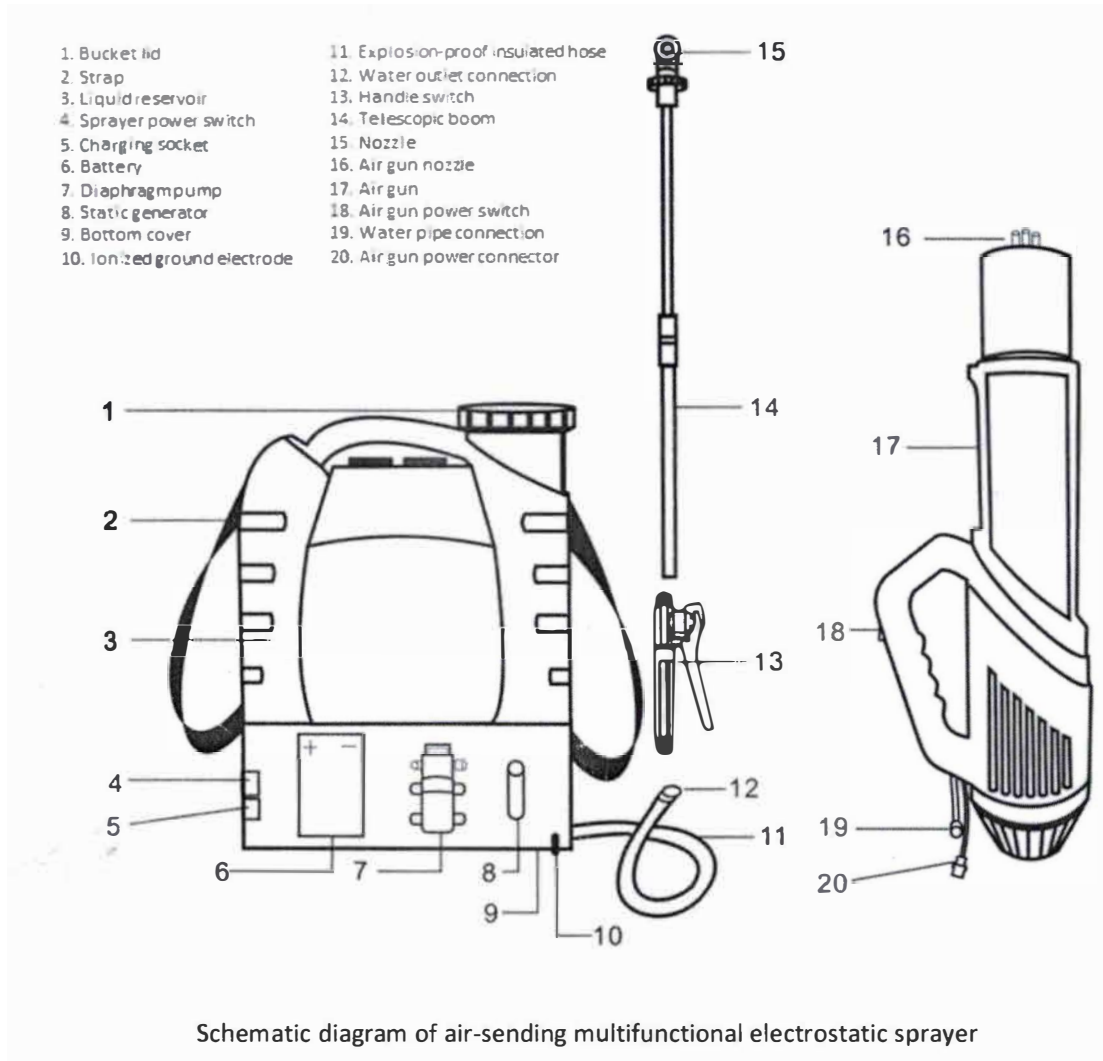

Schematic diagram of air-sending multifunctional electrostatic sprayer

Packing List

No.	Description	Quantity	Remark
1	Sprayer main unit	1	
2	Charger	1	
3	User manual	1	
4	Single nozzle (with hood)	1	Electrostatic spray
5	Double nozzle	1	Electrostatic spray
6	Boom O-ring	2	
7	Nozzle sealing flat washer	2	
8	Telescopic boom	1	
9	Adjustable nozzle	1	
10	Air gun	1	
11	Fine mist 3 nozzle	1	Use with air gun